

# C67 RXX67

AQUABRASS

/ Garniture ronde pour valve déviateur

Fiche technique

R2267 - 2 voies partagées





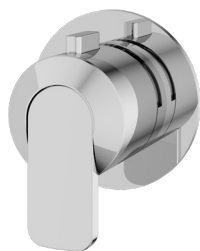
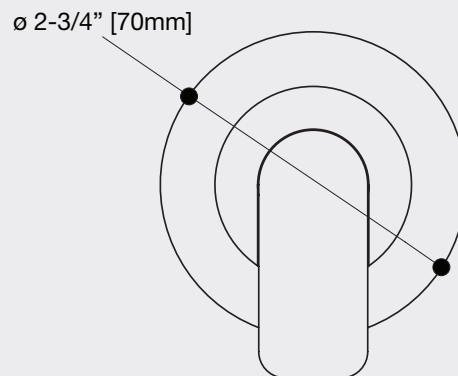
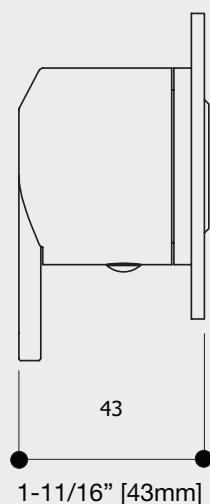

R1267 - 2 voies non-partagées Conforme à CalGreen

R2367 - 3 voies partagées

R1367 - 3 voies non-partagées Conforme à CalGreen



- Caractéristiques**
- Laiton massif
  - Design contemporain
  - Plaque mince Ø 2-3/16" x 3-3/8"
  - Poignées incluses
  - Cartouche déviateur Fluehs incluse
  - **Valve 61934 non incluse**

Finis	
	Chrome Poli (PC)
	Noir (BK)
	Nickel Brossé (BN)
	Nickel Poli (PN)
	Chrome Noir Brossé (BBC)
	Or Brossé (BGD)
	Or (PGD)

**Garantie**      **Résidentielle:** Garantie à vie limitée au premier acheteur  
**Commerciale:** 2 ans

**Code & Conformité**

(la garantie complète est disponible sur [www.aquabrass.com/garantie](http://www.aquabrass.com/garantie))